

VERTICAL BLINDS



3DAYBLINDS®
YOU'LL LOVE THE TREATMENT

GETTING STARTED

A few simple tools are required:



Steel Tape Measure



Pencil

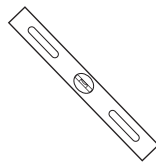

Level
(for outside mount)



Power Drill and
Drill Bits



Flathead & Phillips
Screwdriver



Awl (or tool for starting
a screw hole)

Included in your order is all the hardware necessary for a normal installation. Depending on the mounting surface, fasteners other than the screws provided may be required. Wall board and plaster require the use of anchors such as expansion or toggle bolts. Bricks, tile and stone need special plugs and drill bits. Wood should always be pre-drilled to avoid splitting.

Professional installation is also available in most areas, call 800-800-3329.

OPTIONAL HARDWARE

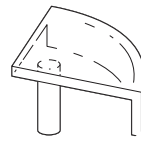

Corner End Cap

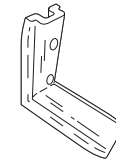

Plastic Corner

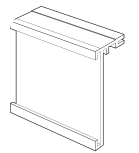

Valance Return

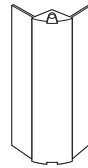

Corner Pieces



Valance Corner
(Closed)
For Vinyl Blinds

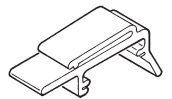

Outside Mount
Valance Clip



Fabric Vane Chain

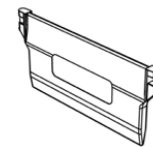

Fabric
Vane Weight

STANDARD HARDWARE



Screws

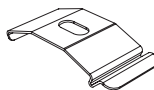

Inside Mount
Headrail Clip

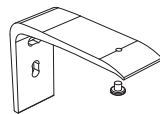

L-Bracket

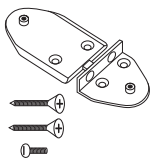

Tension Bracket
With Screws

VALANCE ASSEMBLY

STANDARD VALANCE

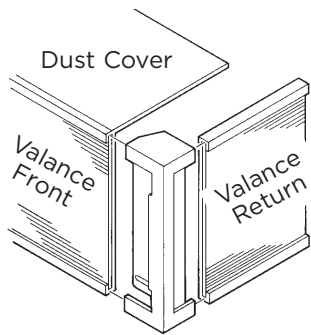

- To Assemble the Valance:
- Insert vinyl inserts into the valance returns.
 - Attach valance returns to the valance using the closed valance corner.

CURVED VALANCE, FABRIC INSERT

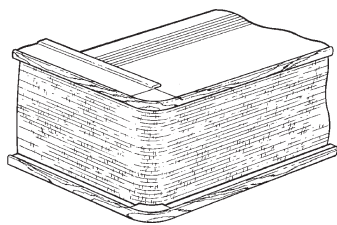
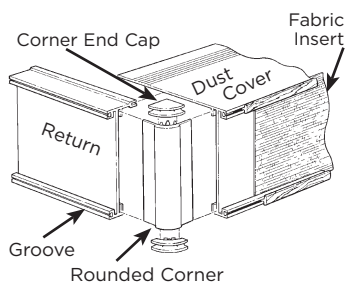
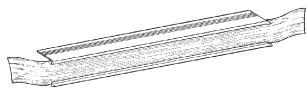

- To Assemble The Valance:
Note: The ordered fabric has already been inserted into the valance.
- Insert one end of the rounded corner into the valance and the other into the valance return. Note that the valance returns have a slot that also clips into the valance dust cover edge.
 - Slide the fabric insert to the end of each, then peel off the protective cover on the double sided tape and stick to fabric.
 - Push the corner End Caps into place on the top and bottom of the rounded corner.
 - Repeat the above process for the other end of the valance. (Excess material may need to be trimmed from returns. Simply use scissors.)

CURVED VALANCE, VINYL INSERT

To Assemble The Valance: Vinyl Insert

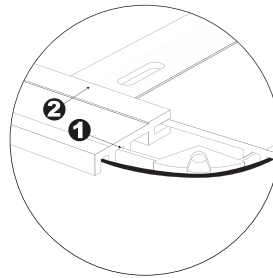
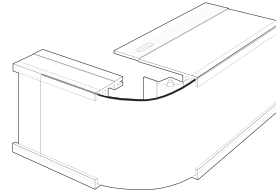
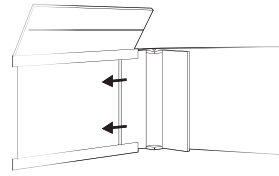

- The ordered vinyl have already been inserted into the valance.
- Insert the valance returns into the rounded corner pieces.
- Slice the vinyl insert to the end of each return, then peel off the protective cover on the double sided tape and paste in the vinyl.

Note: For PVC insertion, trim off the excess with a utility knife by scoring the back of the insertion and snap it off.

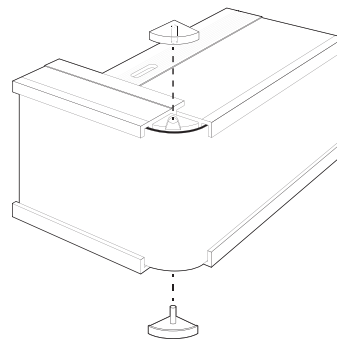

- Insert the four plastic End Caps top and bottom corners and push to secure entire valance
- Valance is ready to be installed

CORONADO VALANCE

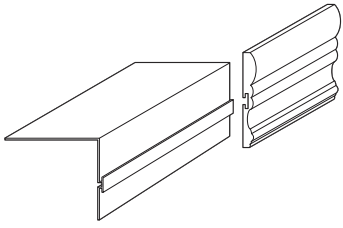

- Slide Coronado Valance onto dust cover using the groove on the back of the valance as shown.
- Insert Plastic corner into the valance and returns

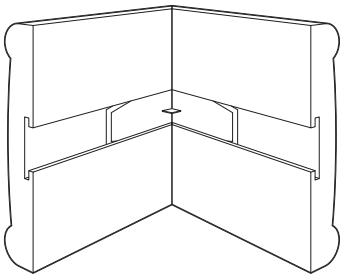
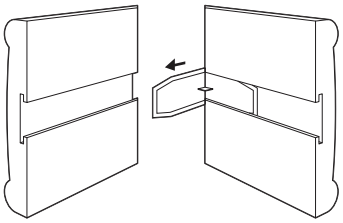
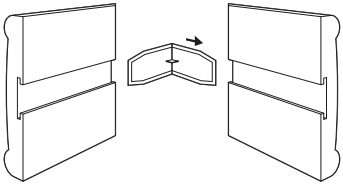

MOUNTING CLIP / BRACKET PLACEMENT

FOR BLIND WIDTH UP TO 37"

Place 1 Mounting Clip/Bracket on each end at 1 1/2" from the end.

FOR BLIND WIDTH 37 1/8" - 41"

Place 1 Mounting Clip/Bracket on each end at 1 1/2" from the end and one in the center.

FOR STANDARD/REVERSE DRAW BLIND WIDTH 41 1/8" - 118"

Place 2 Mounting Clip/Brackets on each end at 1 1/2" and 3 1/2" from the end and 1 on the non control side at 1 1/2" from the end. The remaining Mounting Clip/Bracket(s) should be evenly spaced throughout the headrail.

FOR CENTER OPEN BLIND WIDTH 41 1/8" - 118"

Place 2 Mounting Clip/Brackets on each end at 1 1/2" and 3 1/2" from the end. The remaining Mounting Clip/Bracket(s) should be evenly spaced throughout the headrail.

INSIDE MOUNT

INSIDE MOUNT WITHOUT A VALANCE BRACKET INSTALLATION

BEFORE YOU START: A minimum window depth of 2 7/8" for 3 1/2" vanes, 3 3/4" for 5" vanes and 6 1/4" for 10" vanes is required in order for the blind to operate properly. Be sure to check for any obstructions, such as window cranks or door handles that may add to this minimum depth.

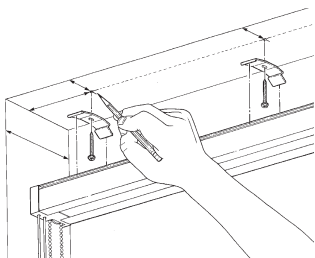

To install the Mounting Clips:

- Mounting clips must be positioned flat against the top of the window casing with the "tail" of the mounting clip positioned closest to the window.
- Mark the casing with a pencil.
- Using a drill and a 1/16" drill bit or an awl, make a small pilot hole at each pencil mark.
- Install the mounting clip using the screw provided.
- Repeat this procedure for the opposite end of the window.
- Install any additional mounting clips provided, making sure that all screw holes are marked 1" from the front edge of the window casing.

INSIDE MOUNT WITH A VALANCE BRACKET INSTALLATION

BEFORE YOU START: A minimum depth of 2 7/8" is required in order for the blind to operate properly. Be sure to check for any obstructions such as window cranks or locks that may add to the minimum depth.

NOTE: Before installing the blind, the valance must be pre-assembled.

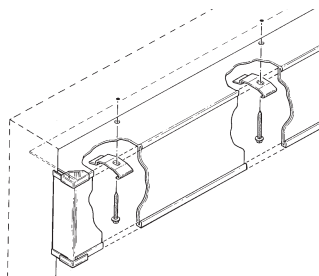

To Install the Mounting Clip and Valance:

- For proper installation, the valance must be positioned **BETWEEN** the mounting clips and the window casing.
- Using a pencil, mark the top of the valance.
- Repeat this process for the opposite end of the valance.
- Mark the remaining screw holes on the valance.
- Using a drill and a 1/8" drill bit, drill holes through the valance at the pencil marks.
- Hold the valance up inside of the window casing making sure that the valance returns butt up against the wall on either side of the window opening and that the dust cover is flat against the top of the window casing.
- Using a pencil, mark the window casing through the holes in the top of the valance.
- Set the valance aside.
- Using a drill with a 1/16" drill bit or an awl, make a small pilot hole at each pencil mark.
- Position the valance over the screw holes in the window casing and mount the left mounting clip using the screw provided. Make sure that the mounting clip is positioned straight and in line with the "tail" closest to the window.
- Repeat this procedure for any additional mounting clips.

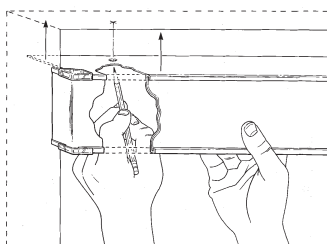
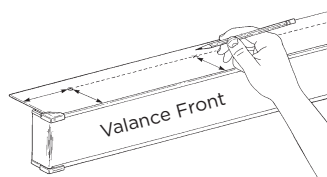

OUTSIDE MOUNT

OUTSIDE MOUNT MOUNTING CLIP / BRACKET INSTALLATION

NOTE: Brackets require a flat vertical mounting surface of 1 7/8" to install.

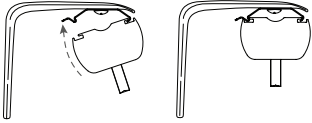

- Snap brackets on to the headrail as stated in the "Mounting Clip/Bracket Placement" section.

- Using the draw cord, draw the carrier clips across the headrail. (see "Vertical Blind Operation")
- Place one vane into the last carrier clip at each end of the headrail. (see "Vertical Vane Installation")

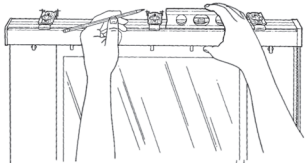

- Hold the vertical headrail above the window opening so the attached vanes are positioned at the desired length. (Floor length blinds should clear the floor by approximately 1/2" - 3/4").

- Once the blind is level, mark the wall above and to the side of each bracket using a pencil.

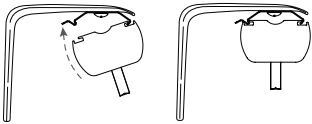

- Remove the brackets from the headrail by pushing up on the tail of each mounting clip. Set the headrail aside.

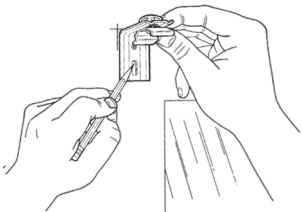

- Facing the window, position one bracket slightly under the left set of pencil marks.
- Mark the screw holes on the mounting surface through the back of the bracket using a pencil.
- Using a drill with a 1/16" drill bit or an awl, make a small pilot hole at each pencil mark.

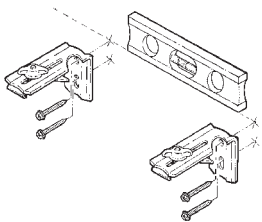

- Mount the bracket using two of the screws provided and repeat this procedure for any remaining brackets making sure all brackets are installed level and in line.
- Go to "Outside Mount Valance Installation".

OUTSIDE MOUNT VALANCE INSTALLATION

NOTE: Standard vertical valance, Curved Valance, Coronado Valance and the Montreal Valance are attached to the headrail in the same manner.

BEFORE YOU START: The headrail and vanes must be installed, see "Headrail Installation" and "Vane Installation".

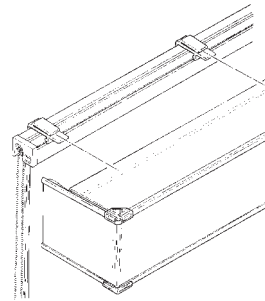
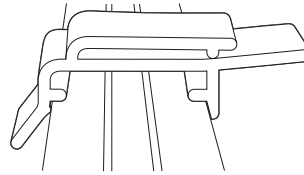
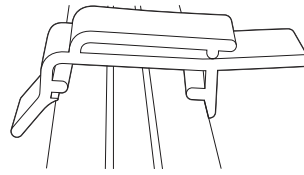

To Install the Valance:

- Attaching Valance Clips to Head Rail
- Place front of clip as shown on the front lip of the head rail
- Push down on the back of the clip until the clip snaps onto head rail
- Slide the valance into the valance clips as shown

CEILING MOUNT

BEFORE YOU START: If you ordered a valance, follow the instructions for an "Inside Mount with a Valance" Make sure that all holes drilled in the valance and ceiling are done so with a drill bit sized to the fasteners purchased.

NOTE: Most ceiling mounts require special fasteners, available at your local hardware store.

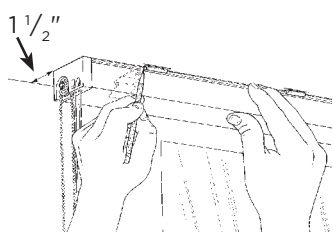

- Snap the mounting clips onto the headrail.
- Additional mounting clips should be spaced accordingly.
- Using the draw cord, traverse the carrier clips across the headrail.
- Hold the vertical headrail up to the ceiling at the desired mounting position, making sure that the back edge of the headrail is positioned at the following minimum from the wall or any obstruction:

- 1 1/2" For 3 1/2" Vanes
- 2 1/2" For 5" Vanes
- 5" For 10" Vanes

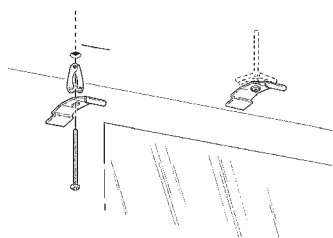
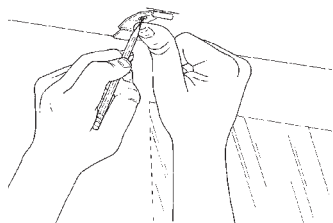
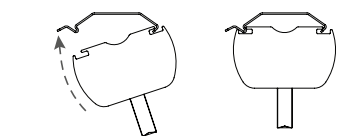

- Using a pencil, mark the front of the mounting clips on the ceiling surface.
- Remove the mounting clips from the headrail by pushing up on the tail of each mounting clip. Set the blind aside.
- Facing the window, align the front of one mounting clip with the left pencil mark on the ceiling and mark the screw hole.
- Using a drill with a drill bit sized to the fasteners purchased, drill a hole at each pencil mark.
- Mount the bracket using the fasteners purchased.
- Repeat this procedure for any remaining brackets making sure that all brackets are installed straight and in line.

HEADRAIL INSTALLATION

NOTE: If you purchased a valance for an outside mount blind, attach the valance clips to the headrail prior to installing the headrail. Valance clips must be spaced evenly across the width of the headrail to support the weight of the valance. Make sure that the valance clips do not interfere with the mounting brackets.

To Install the Headrail:

- Position the headrail so the blind controls are on the desired side of the window.
- Hook the front edge of the headrail into the front of the mounting clips (closest to you).
- Using a firm rolling motion while pressing up slightly on the tail of the mounting clips, rotate the headrail up and back until it snaps into the mounting clips.

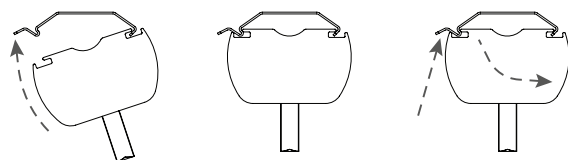

To Remove the Headrail:

- Push up on the tail of each mounting clip to release the headrail from the brackets.

VERTICAL VANE INSTALLATION

NOTE: For free hanging fabric, slide vane weights into the bottom pocket of each vane.

PET PORT: If you ordered your vertical blind with the Pet Port option, you have been provided with 2 different lengths of vertical vanes. The shorter vanes are to be installed over the pet door/obstruction and the longer vanes to cover the length of the opening. You were supplied with 2 extra vanes of each different size. This allows you to install the desired number of vanes over the pet door to achieve the most aesthetically pleasing look.

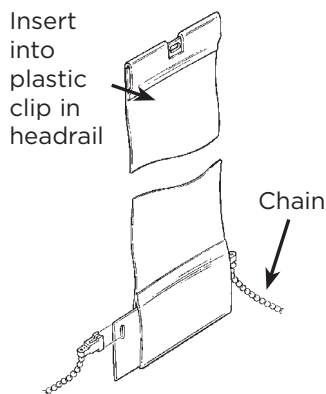

- Using the draw cord, traverse the carrier clips across the headrail.
- Rotate the carrier clips to the open position using the metal tilt chain. (Your blind must be tilted to the open position BEFORE you clip in the vanes).
- Push each vane into the carrier clips until they snap into place.

NOTE: It is preferred that grooved vanes and fabric inserts are inserted with the rigid vinyl side against the longer prong of the plastic clip. This will help to prevent the plastic clip from snagging the fabric.

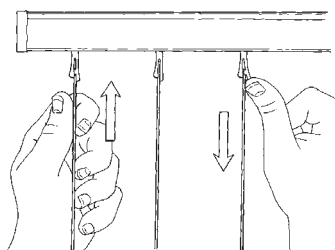

- For free hanging fabric, the plastic clip must be inserted into the top of the fabric vane. Also, snap the plastic clips of the vane chains into the slot of the weight at the bottom of the blind.
- To remove the vanes, gently open the longer prong on the vane hook with your thumb.

VINYL VANES: Upon installation, Vinyl vertical vanes may have static electricity built up causing the vanes to “latch” onto or stick to one another. Simply use a dryer sheet or a damp cloth and mild detergent to wipe down the vanes and remove the static.

CORDLESS VANE INSTALLATION

On cordless rails ordered with rigid PVC there will be a notch on the top of one of the slats. That slat must be placed on the hook next to the control wand. When the slat is installed the wand will be in front of the slat.

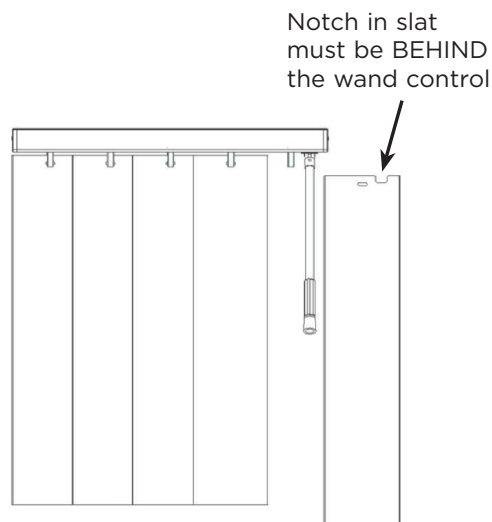

VERTICAL BLIND OPERATION

WARNING: Traversing the vanes in the closed position may cause them to overlap incorrectly. Attempting to rotate vanes that are not overlapped properly will cause damage to your blind. If the nylon tilt chain does not rotate easily, check each vane to make sure they are all overlapped in the same direction.

CORDLESS VERTICAL BLIND OPERATION

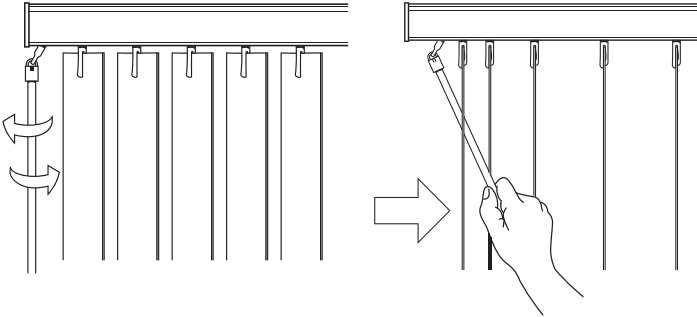

VERTICAL REMOVAL

- To remove the vanes, push the vane up to release the carrier clip and gently pull the vane toward you.

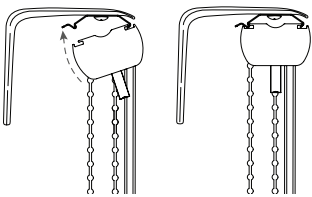

- To remove the headrail, push up on the tail of each mounting clip to release the headrail from the brackets.



3DAYBLINDS®
YOU'LL LOVE THE TREATMENT
800-800-3329 | 3dayblinds.com