

CORNICE BOX



3DAYBLINDS®
YOU'LL LOVE THE TREATMENT

GETTING STARTED

A FEW SIMPLE TOOLS ARE REQUIRED



Steel Tape Measure



Pencil

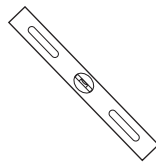

Level



Power Drill and Drill Bits



Phillips Screwdriver



Awl (Or Tool For Starting A Screw Hole)

Included in your order is all the hardware necessary for a normal installation. Depending on the mounting surface, fasteners other than the screws provided may be required. Wallboard and plaster require the use of anchors such as expansion or toggle bolts. Bricks, tile or stone need special plugs and drill bits. Wood should always be pre-drilled to avoid splitting.

Professional installation is also available in most areas, call 800-800-3329.

STANDARD HARDWARE

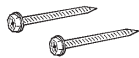

Screw

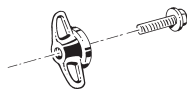

Wing Nut and Bolt

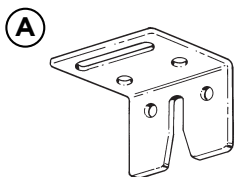

Mounting Bracket A
for 1 1/4" to 2"
Cornice Depth

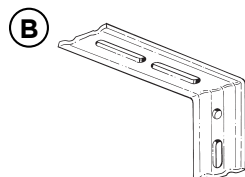

Mounting Bracket B
for 3" to 6"
Cornice Depth

BRACKET INFORMATION

This cornice box was shipped with the proper number of mounting brackets as shown in the following chart:

CORNICE WIDTH	MOUNTING BRACKETS
10" - 24"	2
24 1/8" - 48"	3
48 1/8" - 60"	4
60 1/8" and up	5

OUTSIDE MOUNT

If you ordered an outside mount window covering with your outside mount cornice box, install the blind first. Once the blind is installed you may want remove it from the brackets and set it aside while installing the cornice box.

Each bracket must firmly support the weight of the cornice. Mounting into wood studs is preferred. When this is not possible (e.g. mounting into sheetrock without wood studs, mounting into material such as stone or brick), alternative hardware (not included) should be used.

- Hold the cornice up to the desired mounting position. The top of the cornice's dust cover must be at least 2 1/8" from the top of the window casing. Mark the wall along the top of the dust cover.

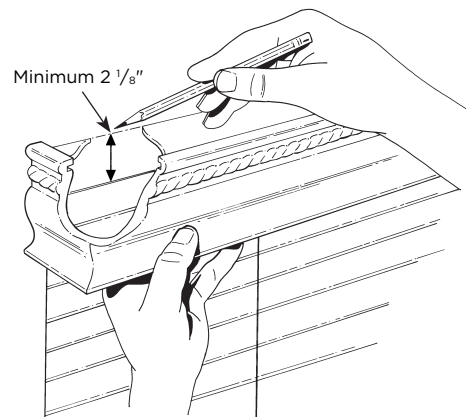

- Using the mark on the wall as your guide, place the top of each mounting bracket $\frac{1}{4}$ " below the line. Brackets should be equidistant from one another throughout the width of the window opening. Ensure each bracket is aligned and level and mark the wall through the hole in each bracket.

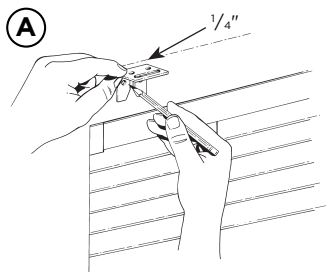

Mounting Bracket A

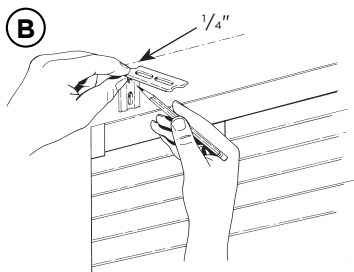

Mounting Bracket B

- Using a drill with a $\frac{1}{16}$ " drill bit or an awl make a small pilot hole at each pencil mark. Mount each bracket using two of the screws provided.

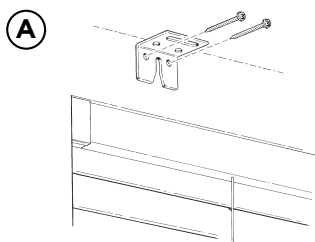

Mounting Bracket A

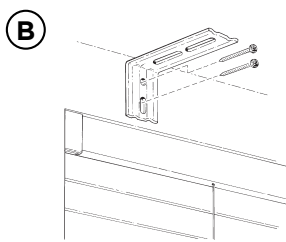

Mounting Bracket B

- Set the cornice on top of the mounting brackets in the desired mounting position. Mark the underside of the dust cover through the bottom of each bracket.

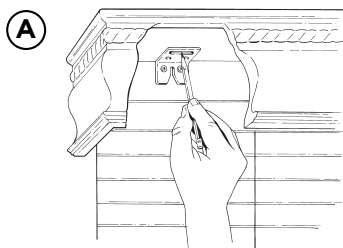

Mounting Bracket A

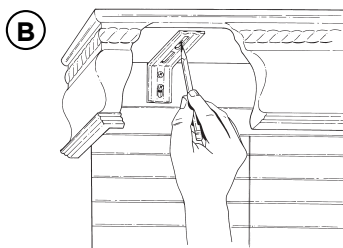

Mounting Bracket B

- Remove the dust cover and use a $\frac{3}{16}$ " drill bit to drill a hole through the dust cover at each pencil mark.

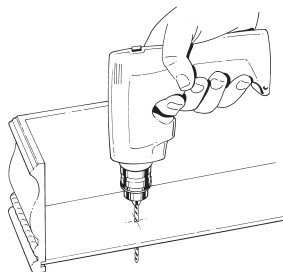

- Set the cornice back on top of the mounting brackets so the holes through the dust cover are positioned over each bracket. Insert a $\frac{5}{8}$ " bolt through the bracket and tighten it down with the wing nuts provided.

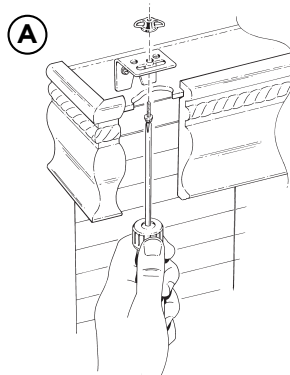

Mounting Bracket A

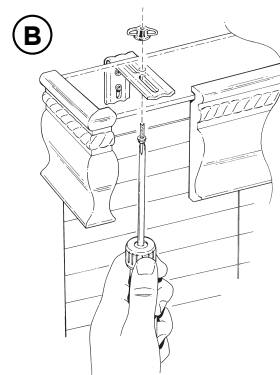

Mounting Bracket B

CLEANING AND CARE

Caring for your wood Cornice Box is very easy. Periodic vacuuming with a soft brush attachment is suggested. To dust the Cornice Box, use a lamb's wool duster or a soft clean cloth to avoid scratching the finish. DO NOT sponge clean or use abrasive household cleansers. Corrosive chemicals may stain or damage the Cornice Box.

