

2 & 2 1/2" WOOD & FAUX WOOD & ANGLED SLAT BLINDS

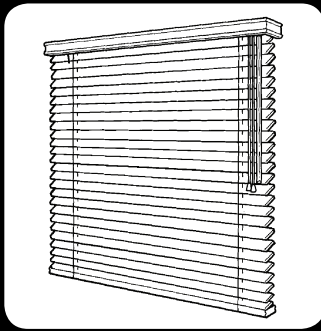

3DAYBLINDS®
YOU'LL LOVE THE TREATMENT

GETTING STARTED

A few simple tools are required:



Steel Tape Measure



Pencil

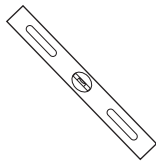

Level



Power Drill and
Drill Bits



Flathead & Phillips
Screwdriver



Awl (or tool for starting
a screw hole)

Included in your order is all the hardware necessary for a normal installation. Depending on the mounting surface, fasteners other than the screws provided may be required. Wall board and plaster require the use of anchors such as expansion or toggle bolts. Bricks, tile and stone need special plugs and drill bits. Wood should always be pre-drilled to avoid splitting.

Professional installation is also available in most areas, call 800-800-3329.

STANDARD HARDWARE

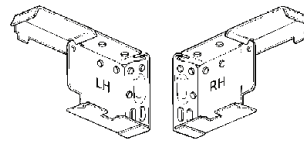

End Brackets
(Open Position LH & RH)

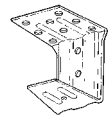

Center Support
Bracket(s)

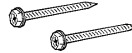

Screws



Valance Clips

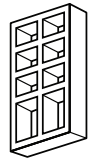

Spacer Block
(standard for 2 1/2" Wood
& Faux Wood outside
mounted blinds only)

OPTIONAL HARDWARE

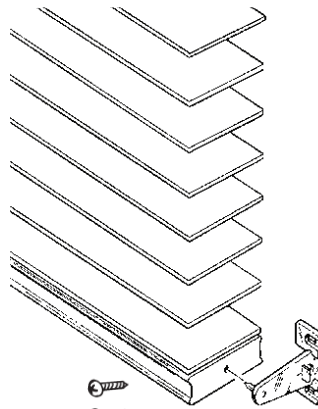

Hold Down Brackets
with Screws

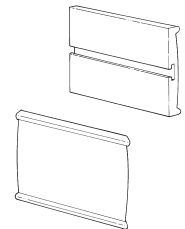

Valance & Returns

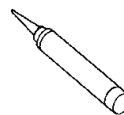

Glue



Valance Return
Clips

INSIDE MOUNT

- Facing the window, hold the end bracket marked “LH” in the upper left hand corner of the window against the top and side of the window casing.
- Position the front edge of the closed bracket:

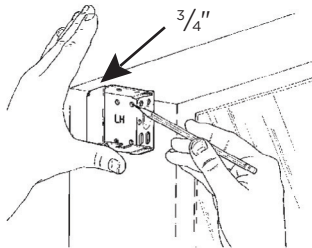
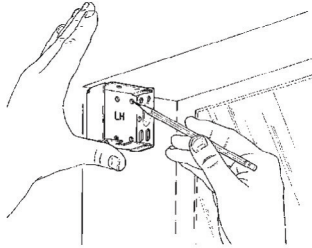

- Flush with the front of the window casing if you are mounting your blind in a window with the minimum depth.

- $\frac{3}{4}$ " back to have the valance flush with the front of the window casing.

NOTE: Be sure to check for any obstructions such as window cranks or which may require different bracket locations.

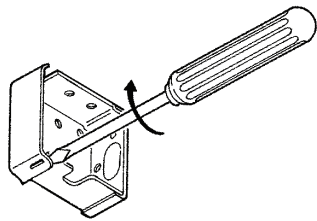

- Mark the window casing through the holes in either the side or top of the end bracket. For maximum stability, the marks should be made diagonally.
- Using a drill with a $\frac{1}{16}$ " drill bit or an awl, make a small pilot hole at each mark.
- Using a flathead screwdriver, open the latches of the end brackets.

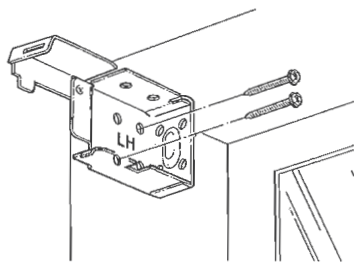

- Mount the bracket using two of the screws provided.
- Repeat this procedure for the right end bracket.

TO INSTALL CENTER SUPPORT BRACKETS:

- If your hardware packet includes one center support bracket, position it as close to the top center of the window casing as possible. If more than one center support bracket has been provided, position them equidistant from the end brackets and each other.

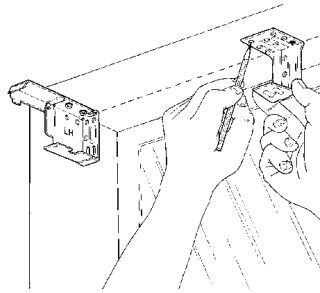

- Align the back of the center support bracket(s) with the back end of the mounting brackets. The alignment is crucial for proper blind installation.
- Mark the window casing through the holes in the top of the center support bracket. For maximum stability, the marks should be made diagonally.

WARNING: Do not locate the center support brackets over any of the moving parts in the headrail.

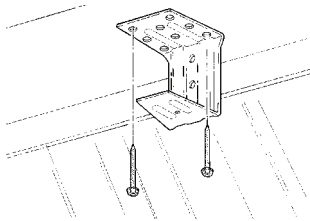

- Using a drill with a $\frac{1}{16}$ " drill bit or an awl, make a small pilot hole at each mark.
- Mount each of the bracket(s) using two of the screws provided.

Proceed to “Valance Return Assembly”.

OUTSIDE MOUNT

- Unwrap the cellophane from around the blind stack.
Caution: DO NOT cut the cellophane as the cords or ladders supporting the blind may be inadvertently cut.
- Lower the blind to its full length. (See “Blind Operation”.)

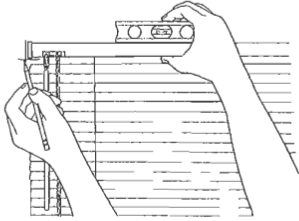

- Hold the blind up to the desired mounting position.
- Once the blind is level, mark the wall at the lower corners of each end of the headrail using a pencil.

- Draw the blind completely up and set it aside.

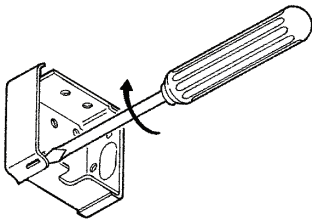

- Using a flathead screwdriver, open the latches of the end brackets.

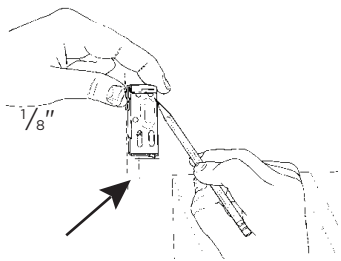

- Facing the window, position the end bracket marked “LH” above the top left corner of the window, $\frac{1}{8}$ ” TO THE LEFT of the pencil marks.
- Using a pencil, mark the wall through the holes in the back of the end bracket. For maximum stability, the pencil marks should be made diagonally.
- Using a drill with a $\frac{1}{16}$ ” drill bit or an awl, make a small pilot hole at each pencil mark.

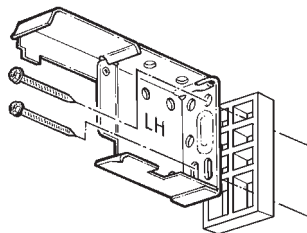
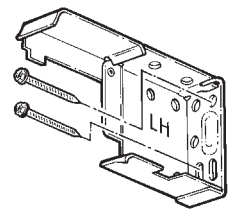

- For 2” Wood & Faux Wood & Angled Slat Blinds mount the bracket using two of the screws provided.
- For 2 1/2” Wood & Faux Wood Blinds mount the bracket using one spacer block and two of the screws provided.
- Mount the bracket using the 2 screws provided.
- Repeat this procedure for the right end bracket.

TO INSTALL CENTER SUPPORT BRACKET(S):

If your hardware packet includes one center support bracket, position it as close to the center of the mounting surface as possible, making sure it will not interfere with any moving parts. If more than one center support bracket has been provided, position them equidistant from the end brackets and each other, again avoiding all moving parts.

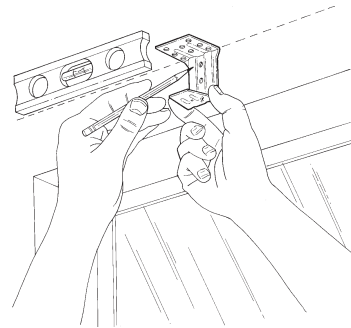

- Make sure all center support brackets are positioned at the same height and are level with the end brackets.
- Using a pencil, mark the mounting surface through the holes in the back of the center support bracket. For maximum stability, the pencil marks should be made in the top two holes of the center support bracket.
- Using a drill with a $\frac{1}{16}$ ” drill bit or an awl, make a small pilot hole at each pencil mark.

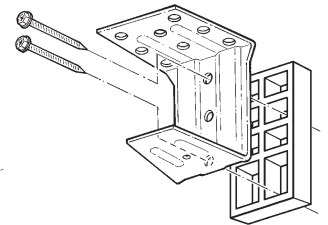
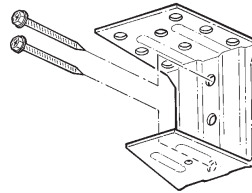

- For 2” Wood & Faux Wood & Angled Slat Blinds, mount the bracket using two of the screws provided.
- For 2 1/2” Wood & Faux Wood Blinds, mount the bracket using one spacer block and two of the screws provided.
- Repeat this procedure for any remaining center support bracket(s).

Proceed to “Valance Return Assembly”.

VALANCE RETURN ASSEMBLY

If you did not order valance returns for your valance, proceed to “Valance Clip Installation”.

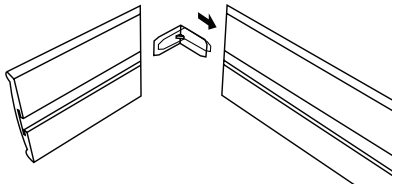

- Slide a valance return clip onto each end of the valance.

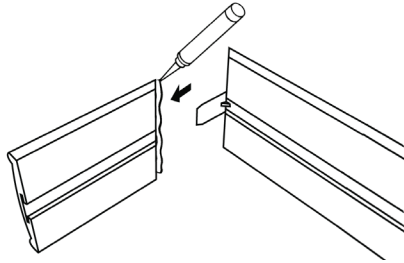

- Apply a thin coat of glue to the mitered end of both the valance and valance returns.

CAUTION: Do not get the glue on the painted/stained surface of the valance. Avoid contact with skin.

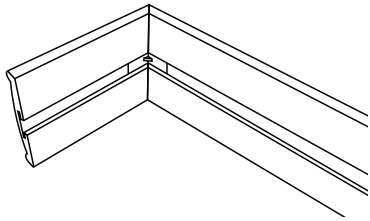

- Slide the valance return clip into the valance, joining the ends of the valance returns with the valance by pressing the mitered edges together firmly for 60 seconds.

- Repeat this procedure for the other end of the valance.
- Allow the glue to dry for at least 10 minutes before installing the valance.

Proceed to “Valance Clip Installation”.

VALANCE CLIP INSTALLATION

If you ordered a blind with a valance, you will need to install the valance clips to the front of the headrail before installing the blind. The valance clips should be spaced equidistant from the end brackets and each other to allow proper support for the entire valance. Make sure the valance clips do not interfere with any moving parts.

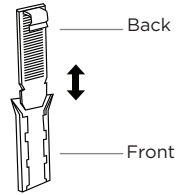

- There are two parts to the valance clip, the front which attaches to the valance and the back which attaches to the headrail.

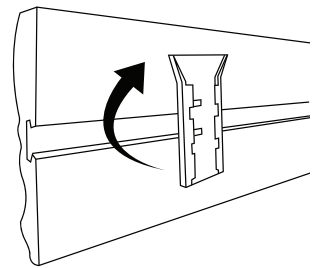
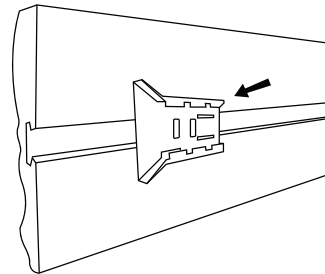

- Snap the front of the valance clip into the groove on the back of the valance and rotate 90°.



- Clip the back of the valance clip onto the headrail, matching the placement of the clips on the valance.

Proceed to “Blind Installation”

BLIND INSTALLATION

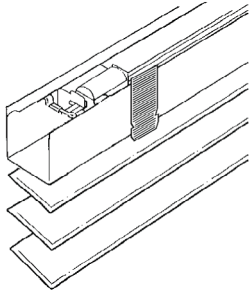

- If you ordered a blind with a valance, you will need to install the valance clips to the front of the headrail before installing the blind following the “Valance Clip Installation” section.

- If you have not already done so unwrap the cellophane from around the blind stack. Caution: DO NOT cut the cellophane as the cords or ladders supporting the blind may be inadvertently cut.

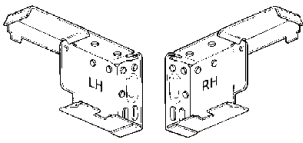

- Be sure the hinged end brackets are in the open position.

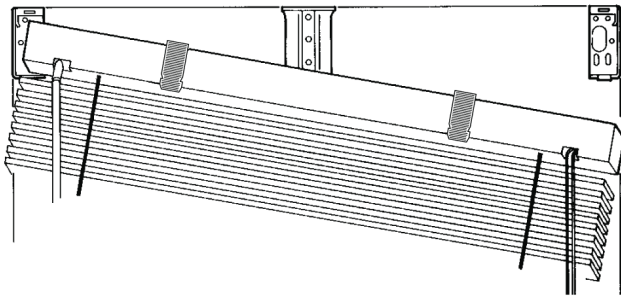

- Insert the headrail into the end brackets, making sure that no cords or slats are in the way.
- Close the hinges on the end brackets until you hear them “snap.”
- While supporting the bottom of the blind, unwind the draw cords and gently lower the blind to its full length.

Proceed to “Valance Installation.”

VALANCE INSTALLATION

You will need to have installed the blind following the “Blind Installation” section before installing the valance.

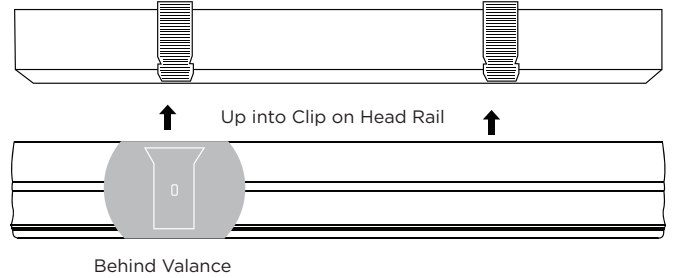

- Aligning the front and back of each of the valance clips and slide the valance onto the headrail.

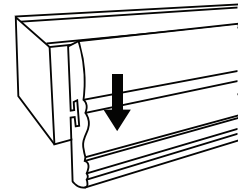
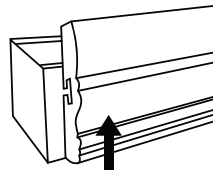

- Once attached adjust the valance to the desired height by sliding it up or down.

TILT WAND ATTACHMENT

(Not applicable for blinds ordered with a cord tilt)

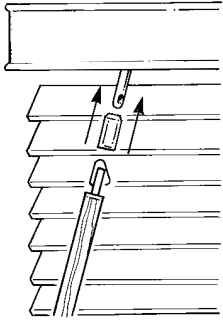

- At the top of the tilt wand (provided separately), you will find a plastic sleeve that covers a metal hook.
- Remove the plastic sleeve on the tilt wand by pulling gently upward.
- Make sure the metal hook attached to the tilt wand is in the open position.
- On one end of the headrail, you will find a small metal shaft with a hole protruding from the headrail.
- Take the plastic sleeve you just removed from the tilt wand and slide it up and over the shaft protruding from the headrail so that the hole at the end of the shaft is exposed.
- Insert the metal hook into the hole in the shaft.

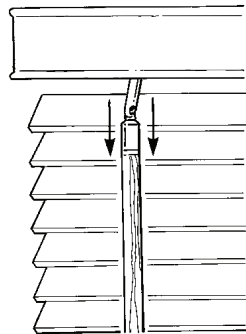
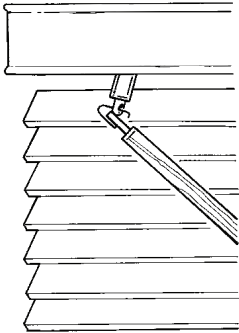

- Slide the plastic sleeve down the shaft and over the tilt wand hook until it is secure.

BLIND OPERATION

CORDED

- To tilt the slats, twist the tilt wand. If you ordered a cord tilt, YOU MUST take one cord in each hand applying slight tension to each cord, and pull gently down to tilt the slats to the desired angle.
- Do not attempt to raise or lower the blind unless the slats are in a completely open (horizontal) position.
- To raise the blind, pull the lift cords down.
- To engage the lock, pull the lift cords down and toward the outside of the blind.
- To lower the blind, pull the lift cords down and toward the center of the blind and allow the cords to slide slowly through your hand.

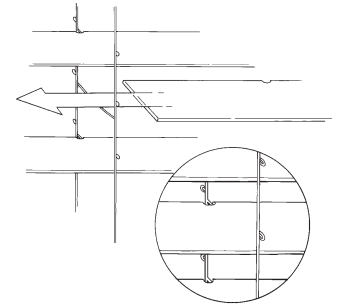
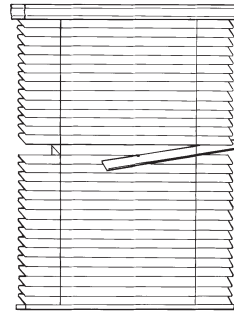

NOTE: Light-less® Blinds are manufactured without ladder holes in each slat to allow for tighter closure and superior light control. As such, slats may become dislodged from the support ladders during shipping. If this occurs, the slats are easy to reposition. The notch on the slat is to be placed at the rear of the blind.

ULTRALIFT CORDLESS™

- To tilt the slats, twist the tilt wand.
- Do not attempt to raise or lower the blind unless the slats are in a completely open (horizontal) position.
- To raise and lower the blind, press the button on the bottomrail while simultaneously moving the blind up or down into the desired position.

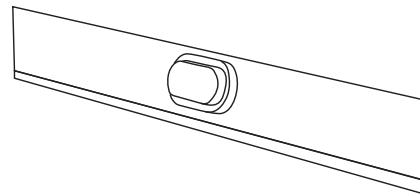

Note: The button must be engaged to raise or lower the blind. Releasing the button will lock the blind into place.

BLIND REMOVAL

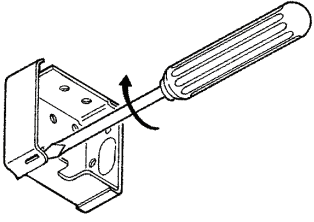

- Using a flathead screwdriver, open the latches of the end brackets.
- Holding onto both ends of the headrail, gently pull the blind forward and out of the brackets, making sure to unhook the headrail from the center support bracket(s), if applicable.

OPTIONAL HARDWARE INSTALLATION

HOLD DOWN BRACKETS

Hold down brackets are used primarily on blinds mounted to doors or in motor homes. If hold down brackets were ordered at the time of purchase, the bottom rail of the blind will be pre-drilled to accommodate the brackets. If you require hold down brackets and no hole appears, simply drill a small hole in the center of the bottom rail using a $\frac{1}{16}$ " drill bit.

- With the blind lowered to its full length, place the pin of each hold down bracket into the hole in each end of the bottom rail.
- Mark the mounting surface, either to the side or back of the window frame, through the holes in the hold down bracket. Make sure the hold down brackets are level and aligned with each other.
- Raise the blind and screw the hold down brackets into the mounting surface using the screws provided.

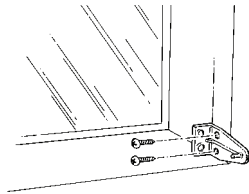
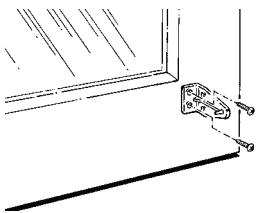

- Mount the hold down bracket to the side or back of the window frame so that the pin lines up with the front hole in the bottom rail end cap with the blind fully lowered.

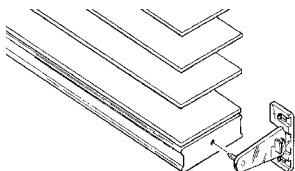

- Lower the blind and flex the hold down bracket outward so that the pin can be inserted into the hole in the bottom rail.



WARNING

Young children can STRANGLE in cord and bead chain loops. They can also wrap cords around their necks and STRANGLE.



- Always keep cords and bead chains out of children's reach.
- Move cribs, playpens, and other furniture away from cords and bead chains. Children can climb furniture to get to cords.
- Do not tie cords together. Make sure cords do not twist together and create a loop.

ANSI/WCMA A1001-2014 5.2.3

Young children can STRANGLE in cord and bead chain loops and in the loop(s) above the cord connector. They can also wrap cords around their necks and STRANGLE.



- Always keep cords and bead chains out of children's reach.
- Move cribs, playpens, and other furniture away from cords and bead chains. Children can climb furniture to get to cords.

ANSI/WCMA A1001-2014 5.2.3

Inner cords can pull out to form a loop, which can strangle a young child.

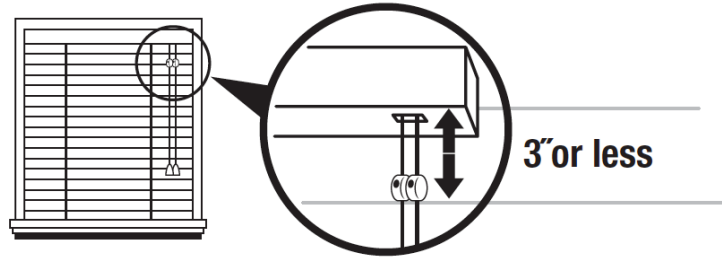

- Inner cord stop devices can reduce this risk if positioned correctly on the pull cords.
- If inner cord stop devices are more than 3 in (76 mm) below the headrail when the blind is fully lowered, move them closer by loosening, but not untying, the knot surrounding the cord stop and sliding the cord stop upwards. Repeat for any remaining cords



3DAYBLINDS®
YOU'LL LOVE THE TREATMENT

800-800-3329 | 3dayblinds.com

Part # PM-048 © 2018 3 Day Blinds Corporation 02/18