

# ROMAN SHADES

## Corded

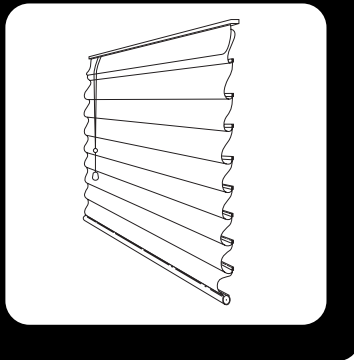

**3DAYBLINDS®**  
YOU'LL LOVE THE TREATMENT

### GETTING STARTED

A few simple tools are required:



Steel Tape Measure



Pencil

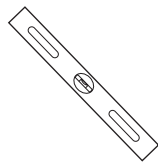

Level  
(for outside mount)



Power Drill and  
Drill Bits



Flathead & Phillips  
Screwdriver



Awl (or tool for  
starting a screw hole)

Included in your order is all the hardware necessary for a normal installation. Depending on the mounting surface, fasteners other than the screws provided may be required. Wall board and plaster require the use of anchors such as expansion or toggle bolts. Bricks, tile and stone need special plugs and drill bits. Wood should always be pre-drilled to avoid splitting.

Professional installation is also available in most areas, call 800-800-3329.

#### STANDARD HARDWARE

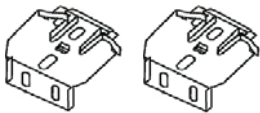

Mounting Brackets  
with Screws

#### OPTIONAL HARDWARE



Extension Bracket

#### OPTIONAL HARDWARE cont.

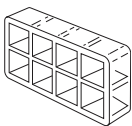

Spacers

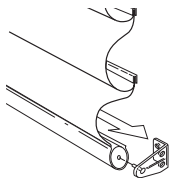

Hold Down Brackets  
with Screws



Valance Brackets

### BRACKET INFORMATION

The brackets you received with your product are required for proper installation. Brackets should be installed 3" from each end. Any additional brackets will need to be evenly spaced between the two end brackets.

### INSIDE MOUNT

- Mount the brackets to the top of the window frame, 3" in from each outer edge and 3/16" back from the front edge of the frame for a flush look.

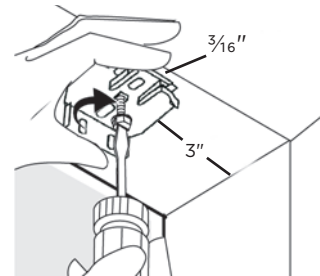

- Additional brackets will be supplied with wider shades. Align and mount additional brackets spaced equally between outer brackets.
- If shade came with a valance, be sure to install the valance bracket with the installation bracket at this time. See Valance Installation on page 2.
- Proceed to "Shade Installation".

### BRACKET INSTALLATION

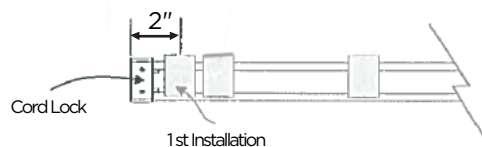

- On shades 84" to 96" wide it is recommended to use a second bracket located next to the end bracket at the Cord Lock.

## OUTSIDE MOUNT

Center and align the top rear of the shade headrail over the window opening at the desired height. Make a mark 3" in from each outer edge of the shade headrail.

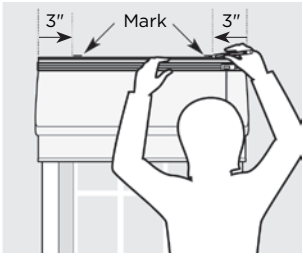

- Align the top rear of the mounting brackets with these marks. Use a level to make sure mounting brackets are at the same height.

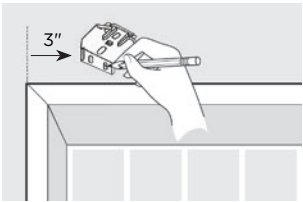

- Additional brackets will be supplied with wider shades. Align and mount additional brackets spaced equally between outer brackets.
- If valance is ordered, be sure to install the valance bracket with the installation bracket at this time. See Valance Installation below.

## SHADE INSTALLATION

If you have not already done so, unwrap the cellophane from around the shade. DO NOT CUT the cellophane as the fabric or the cords supporting the shade may be inadvertently cut. Also, unwind the shade cord and let it hang down in front of the shade.

NOTE: If you ordered a Top Down only shade, the lift cords have been pulled up through the top of the shade and wrapped to the headrail. When you unwrap the cellophane, the cords will be allowed to hang freely. Before installing the headrail, make sure the cords are not wrapped around the top of the headrail.

Unwind the cord from the shade but keep the rubber band around the shade stack.

- Hold the shade up near the brackets and insert the front clip of the bracket into the front groove of the rail.
- Make sure the shade is centered in the window opening.
- Push the rail back and up until the back clips of the bracket are inserted in the back groove of the rail.



## SHADE OPERATION

### CORDED SHADE

- To raise the shade, pull the cord down and away from the fabric, toward you. Make sure the cord does not rub on the edge of the fabric, the shade, or the valance.
- To lower the shade, pull the cord down to release the cord lock and lower the shade.
- To lock the shade at the desired length, raise or lower the shade as instructed above. When your shade is at the length you desire, move the cord slightly towards the outside edge of the shade and release the cord.

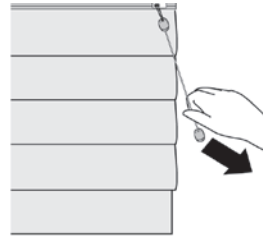

Lock

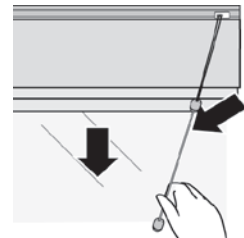

Unlock

### TOP DOWN BOTTOM UP

Follow "Corded Shade" instructions for shade operation. This shade is different because it has two sets of cords.

One set of cords controls the center rail, the other is for the bottom rail.

## VALANCE INSTALLATION

Hold the Valance Bracket together with the Installation Bracket, make sure the Valance Bracket is on top. Note: do not nut and bolt them together. Now install the two brackets together into the sill or wall. Next, install the shade into the installation bracket and then slide the valance dust cover into the metal Valance Bracket shown below.

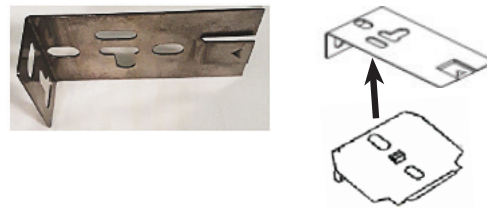

Slide Valance Dust Cover into Valance Bracket above center tab but below the two side tabs.

## SHADE REMOVAL

Draw the shade completely up. (See “Shade Operation”) Push shade rail back and rotate the back of the shade down to release.

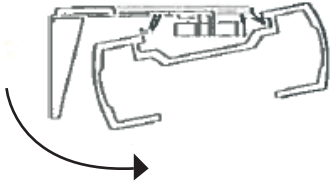

- Rotate the back of the headrail down and carefully lift the headrail off of the front hooks of the mounting brackets.

## OPTIONAL ACCESSORIES

### EXTENSION BRACKETS

Extension brackets can be used to project the shade further into the room (over window cranks, door knobs etc.)

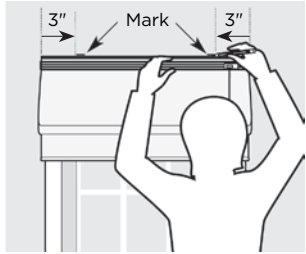

- Center and align the top rear of the shade headrail over the window opening at the desired height. Make a mark 3” in from each outer edge of the shade headrail. Align the top rear of the extension brackets with these marks.
- Use a level to make sure extension brackets are at the same height.

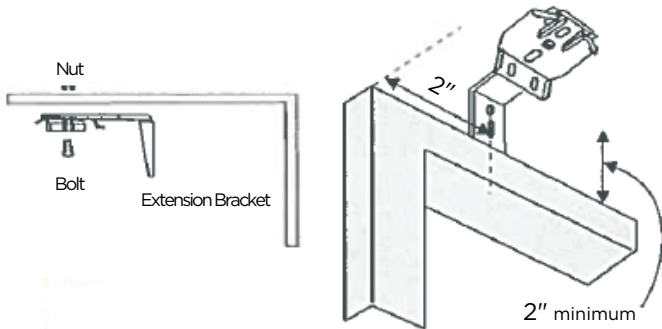

- Attach each mounting bracket to an extension bracket using the nuts bolts and washers provided.
- Mount the extension bracket to the wall per the instructions for an “Outside Mount”, using a level and making certain that all mounting brackets are level and project the same distance from the mounting surface. For maximum stability, install the screws diagonally from one another.
- Install the shade per the directions for “Shade Installation”.

### HOLD DOWN BRACKETS

Hold down brackets are used primarily on shades mounted to doors or in motor homes. There are two small holes in the end caps that are covered by a thin plastic layer. Use the pin on the hold down bracket to push through the center of the end cap and it will break through the plastic layer.

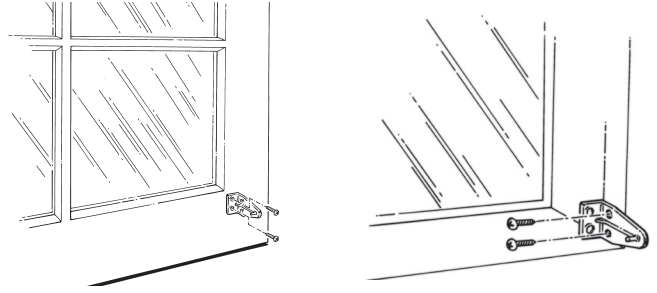

- With the shade lowered to its full length, place the pin of each hold down bracket into the hole in each end of the bottom rail.
- Mark the mounting surface, either to the side or back of the window frame, through the holes in the hold down bracket. Make sure the hold down brackets are level and aligned with each other.
- Raise the shade and screw the hold down brackets into the mounting surface using the screws provided.

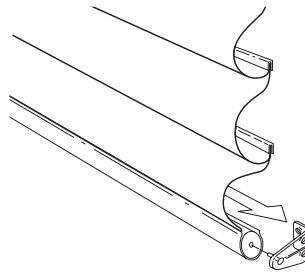

- Lower the shade and flex the hold down bracket outward so that the pin can be inserted into the hole in the end cap.

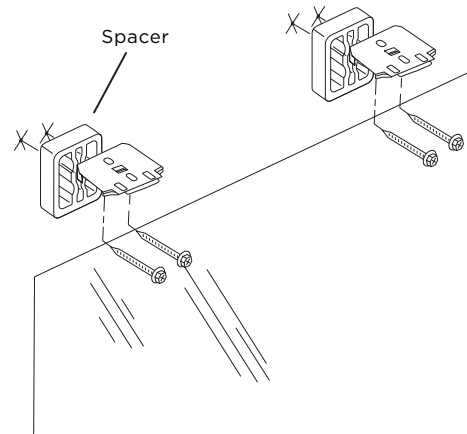

Spacers are available for use on windows with a projected molding. They are  $\frac{3}{8}$ ” thick and allow the shade to be mounted flush with the outside edge of any standard window molding. They are available by contacting our Client Care Team at 800-800-3329.



## WARNING

Young children can STRANGLE in cord and bead chain loops. They can also wrap cords around their necks and STRANGLE.

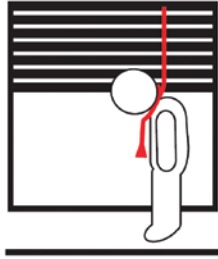

- Always keep cords and bead chains out of children's reach.
- Move cribs, playpens, and other furniture away from cords and bead chains. Children can climb furniture to get to cords.
- Attach tension device to wall or floor. This can prevent children from pulling cords and bead chains around their necks. Fasteners provided with the tension device may not be appropriate for all mounting surfaces. Use appropriate anchors for the mounting surface conditions.

ANSI/WCMA A100.1-2018 5.2.2

## PROTECT YOUR CHILDREN

Be aware that it is possible for children to strangle in window covering cords. To reduce the occurrence of accident, all cords must be kept out of the reach of children, including infants. Cord cleats are an effective way to implement this essential precaution.



Mount the cord cleat at a safe height, taking into account furniture or other objects upon which a child may climb. Then after each use of the shade, simply wrap the excess cord around the cleat. It's fast, easy and safe.

To protect your children, we are pleased to provide cord cleats free of charge with every shade that we manufacture.



**3DAYBLINDS®**  
YOU'LL LOVE THE TREATMENT

800-800-3329 | 3dayblinds.com

Part # PM-055 © 3 Day Blinds LLC 06/20